

UM10475

120 V 21 W 700 mA reference design using SSL2103

Rev. 2 — 21 December 2011

User manual

Document information

Info	Content
Keywords	SSL2103, adjustable, flyback, convertor, dimmable
Abstract	This document describes the correct use of the SSL2103 adjustable flyback convertor for 120 V 21 W 700 mA dimmable LED applications.



Revision history

Rev	Date	Description
v.2	20111221	second issue
Modification:		<ul style="list-style-type: none">• Figure 10 “Demo board circuit diagram” on page 9 changed.
v.1	20110905	first issue

Contact information

For more information, please visit: <http://www.nxp.com>

For sales office addresses, please send an email to: salesaddresses@nxp.com

1. Introduction

1.1 Scope of this document

WARNING

Lethal voltage and fire ignition hazard



The non-insulated high voltages that are present when operating this product, constitute a risk of electric shock, personal injury, death and/or ignition of fire.

This product is intended for evaluation purposes only. It shall be operated in a designated test area by personnel qualified according to local requirements and labor laws to work with non-insulated mains voltages and high-voltage circuits. This product shall never be operated unattended.

The demo board (see [Figure 1](#) and [Figure 2](#)) is a 120 V, 21 W, dimmable LED driver featuring the SSL2103. The board employs a flyback converter to provide a simple and efficient solution for mains dimmable, LED recessed-light applications that require galvanic isolation.

The demo board is designed to highlight high performance dimming, wide dimmer compatibility, cost-effectiveness and high efficiency in dimmable LED driving applications. The demo boards efficient bleeding circuit ensures wide dimmer compatibility and flicker-free dimming operation for leading edge (triac) and falling edge (transistor) dimmers. The board operates at around 70 kHz and produces a constant output current up to 700 mA to drive 8 to 9 LEDs. The corresponding output voltage range is 23 V to 30 V. The optimized circuit design, external MOSFET and valley switching help to achieve efficiency up to 85 %.

[Figure 1](#) and [Figure 2](#) show populated views of the demo board.

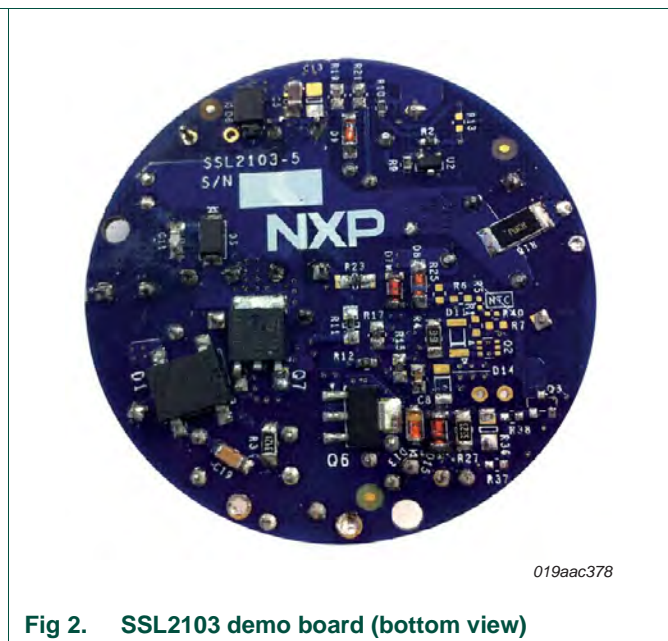
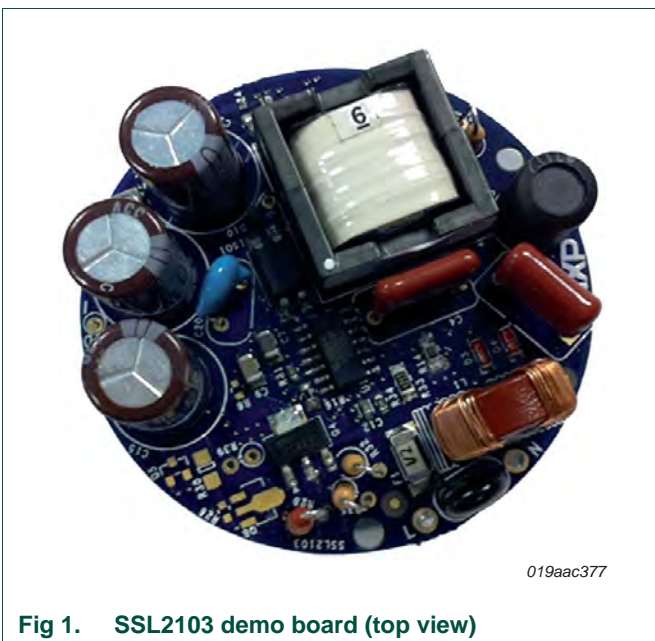

2. Safety warning

Connect the board to the mains voltage. Avoid touching the board while it is connected to the mains voltage at all times. An isolated housing is obligatory when used in uncontrolled, non-laboratory environments. Galvanic isolation of the mains phase using a variable transformer is always recommended.

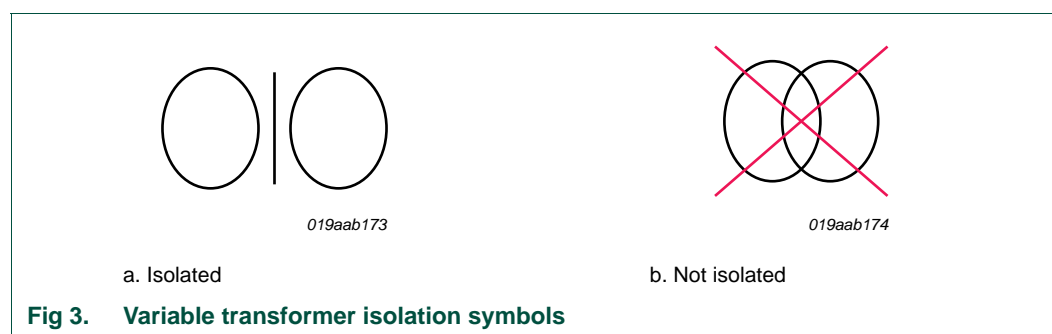

3. Specification

3.1 Demo board performance and specification

Table 1. Performance and specification [\[1\]](#)

Parameter	Conditions	Min	Typ	Max	Unit
input voltage range	60 Hz	106	120	135	V
output voltage		23	28	30	V
output current	$V_I = 120\text{ V}$, $V_O = 28\text{ V}$	450	-	700	mA
switching frequency		50	70	90	kHz
output current ripple	$V_I = 120\text{ V}$, $V_O = 28.7\text{ V}$, $I_O = 700\text{ mA}$	-	27	30	%
input Power Factor	$V_I = 120\text{ V}$, $V_O = 28.7\text{ V}$, $I_O = 500\text{ mA}$ to 700 mA	0.9	0.925	-	
efficiency	$V_I = 120\text{ V}$, $V_O = 28.7\text{ V}$, $I_O = 450\text{ mA}$ to 700 mA	84	84.5	85	%
output current regulation	line = (106 V to 135 V), $I_O = 700\text{ mA}$	-	5	-	%
output current regulation	temp = (0 °C to 85 °C), $I_O = 700\text{ mA}$, $V_I = 120\text{ V}$	-	-	1.1	%
isolation voltage	between primary and secondary	-	3	-	KV

[1] Specification at $T_A = 25\text{ °C}$

4. Functional description

The SSL2103 driver IC is used to configure a flyback converter to generate a regulated output current for driving LEDs. When an input voltage is applied, the SSL2103 is initially powered up from the rectified voltage. When the SSL2103 starts switching, the SSL2103 is then supplied by the auxiliary winding for increased efficiency. See [Figure 10](#).

The flyback converter operates in Discontinuous Conduction Mode (DCM) to minimize magnetic component and switching losses. High-Power Factor (PF) is obtained automatically due to DCM operation. With an operation in Boundary Conduction Mode (BCM) at full load, is efficient, optimized and enhanced by valley switching detection. An external MOSFET is used to allow high-power applications.

When mains dimmers are used, the circuit detects the rectified voltage change and reduces the duty cycle and switching frequency. This action reduces the output current for deep dimming. The demo board adopts a more efficient bleeding circuit. This results in flicker-free deep dimming with a wide range of mains dimmers to increase the dimmer compatibility without sacrificing efficiency. It detects circuit current and if necessary, supplements bleeding current enough for the required hold currents of triac dimmers.

The bleeding circuit ensures the widest dimmer compatibility while keeping the minimum heat generation.

The reference circuit also includes an active damper to increase the efficiency and limit the inrush current during the phase cutting transient. An ElectroMagnetic Interference (EMI) filter is included to comply with the conducted EMI requirement of EN55015/FCC15.

Remark: Nine LEDs were used in the test application for optimal performance of the reference design. The design is adaptable to match other LED solutions.

5. Dimmer compatibility

Several dimmers with different specifications have been tested as the dimming performance of the board varies. [Table 2](#) shows the range of mains dimmers tested for compatibility with the SSL2103 demo board.

Table 2. Dimmer compatibility

Manufacture	Model number	Voltage type	Compatibility
Lutron	S-600	120 V/incandescent	Yes
Lutron	S-600P	120 V/incandescent	Yes
Lutron	S-600H	120 V/incandescent	Yes
Lutron	TG-600PH	120 V/incandescent	Yes
Lutron	DVW-600PH	120 V/incandescent	Yes
Lutron	DVW-603GH	120 V/incandescent	Yes
Lutron	DVM-600PH	120 V/incandescent	Yes
Lutron	DV-603PG	120 V/incandescent	Yes
Lutron	DV-600P	120 V/incandescent	Yes
Lutron	DV Beta Build	120 V/incandescent	Yes
Lutron	DNG-600PH	120 V/incandescent	Yes
Lutron	GL-600PH	120 V/incandescent	Yes
Lutron	CTCL-153PDH	120 V/incandescent	Yes
Lutron	LGCL-153P2	120 V/incandescent	Yes
Lutron	LG-600P	120 V/incandescent	Yes
Lutron	Credenza S31	120 V/incandescent (lamp)	Yes
Leviton	6631	120 V/incandescent	Yes

Table 2. Dimmer compatibility

Manufacture	Model number	Voltage type	Compatibility
Leviton	6602	120 V/incandescent	Yes
Leviton	6602-1	120 V/incandescent	Yes
Leviton	RPI06	120 V/incandescent	Yes
Unknown	GL410A	120 V/incandescent (lamp)	Yes
GE	18021	120 V/incandescent	flicker
GE	52136	120 V/incandescent	flicker

6. Quick setup procedure

The demo board is supplied by 120 V (AC) and drives 8 to 9 LEDs up to 700 mA. The output voltage range of the demo board is between 23 V to 30 V. The output current can be adjusted down to 450 mA with potentiometer (R20) at the output. The LED load is connected to the terminals W3 and W4. The output voltage is limited to 35 V. Connect an LED load to the driver board before powering up the board. This action avoids any potential damage to LEDs due to the inrush current from hot-plugging. See [Figure 4](#).

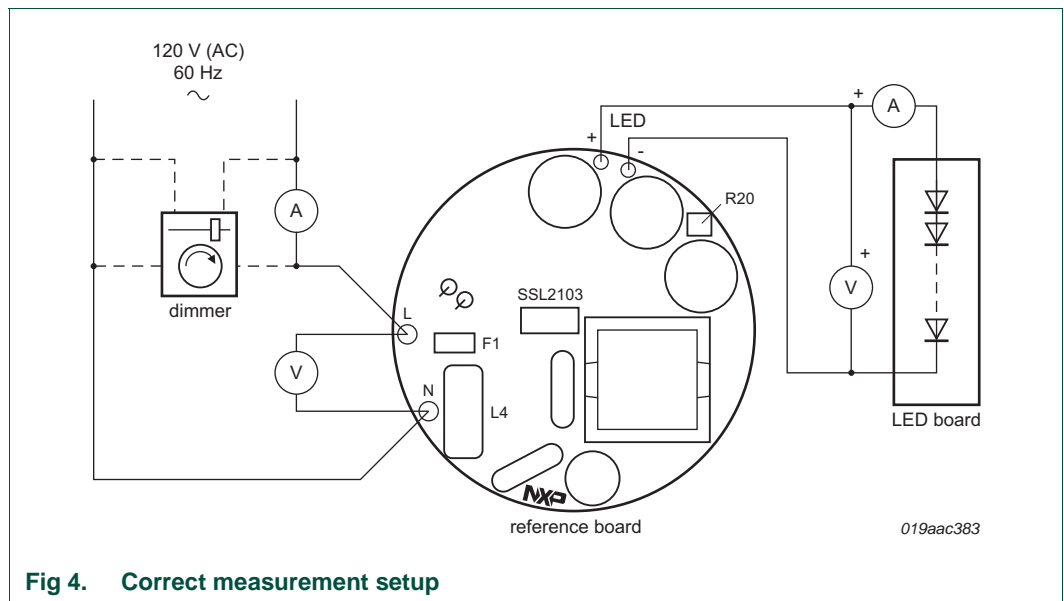
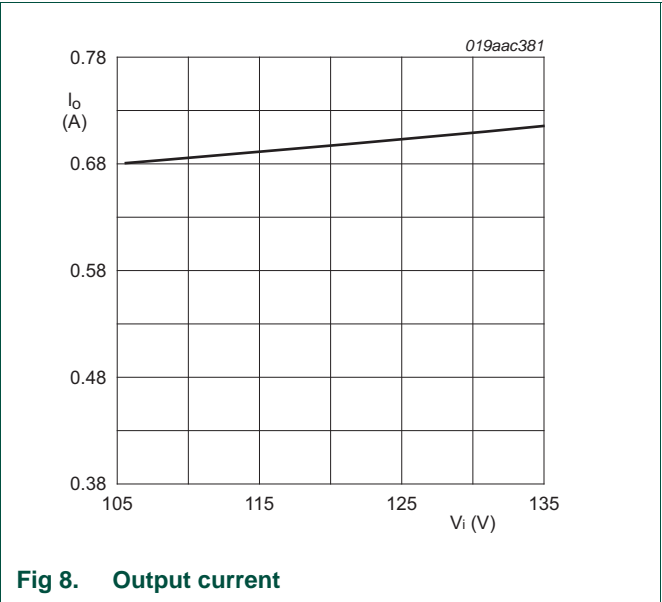
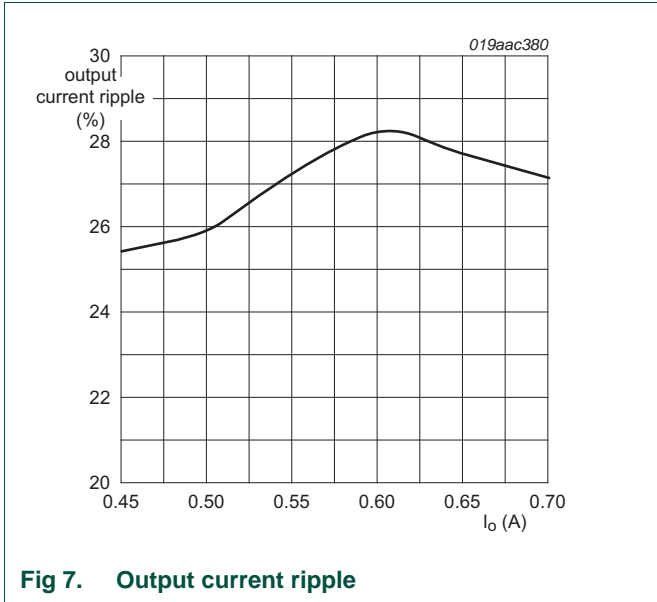
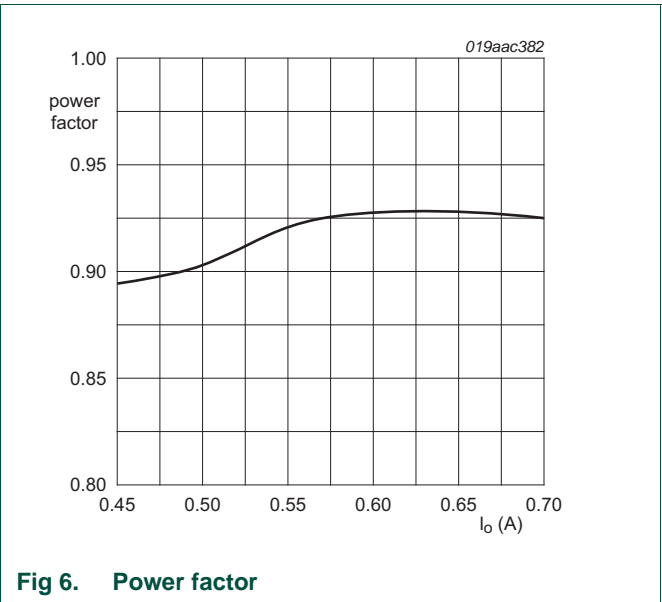
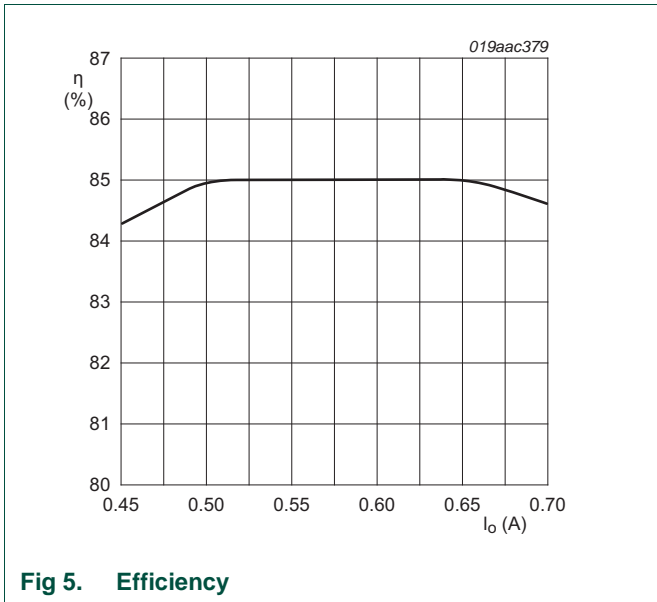

Fig 4. Correct measurement setup

7. Performance data (9 Cree XPE LEDs)

Figure 5 to Figure 8 provided detailed performance test results (9 LEDs) associated with the SSL2103 demo board.



8. EMI performance

The SSL2103 demo board is pre-compliant to EMC regulations as shown in [Figure 9](#).

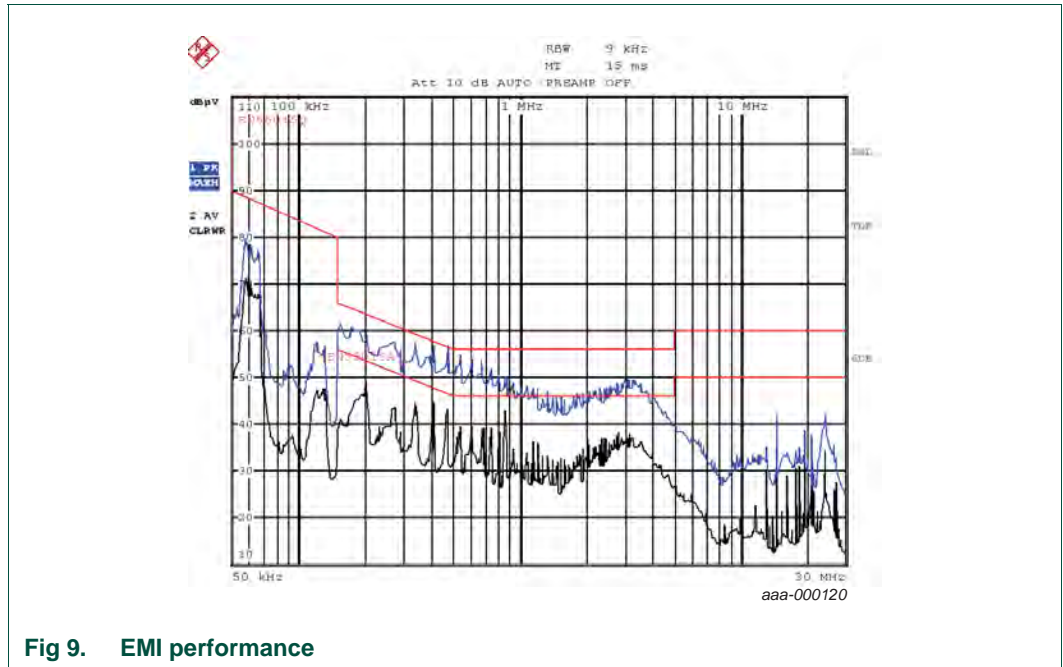
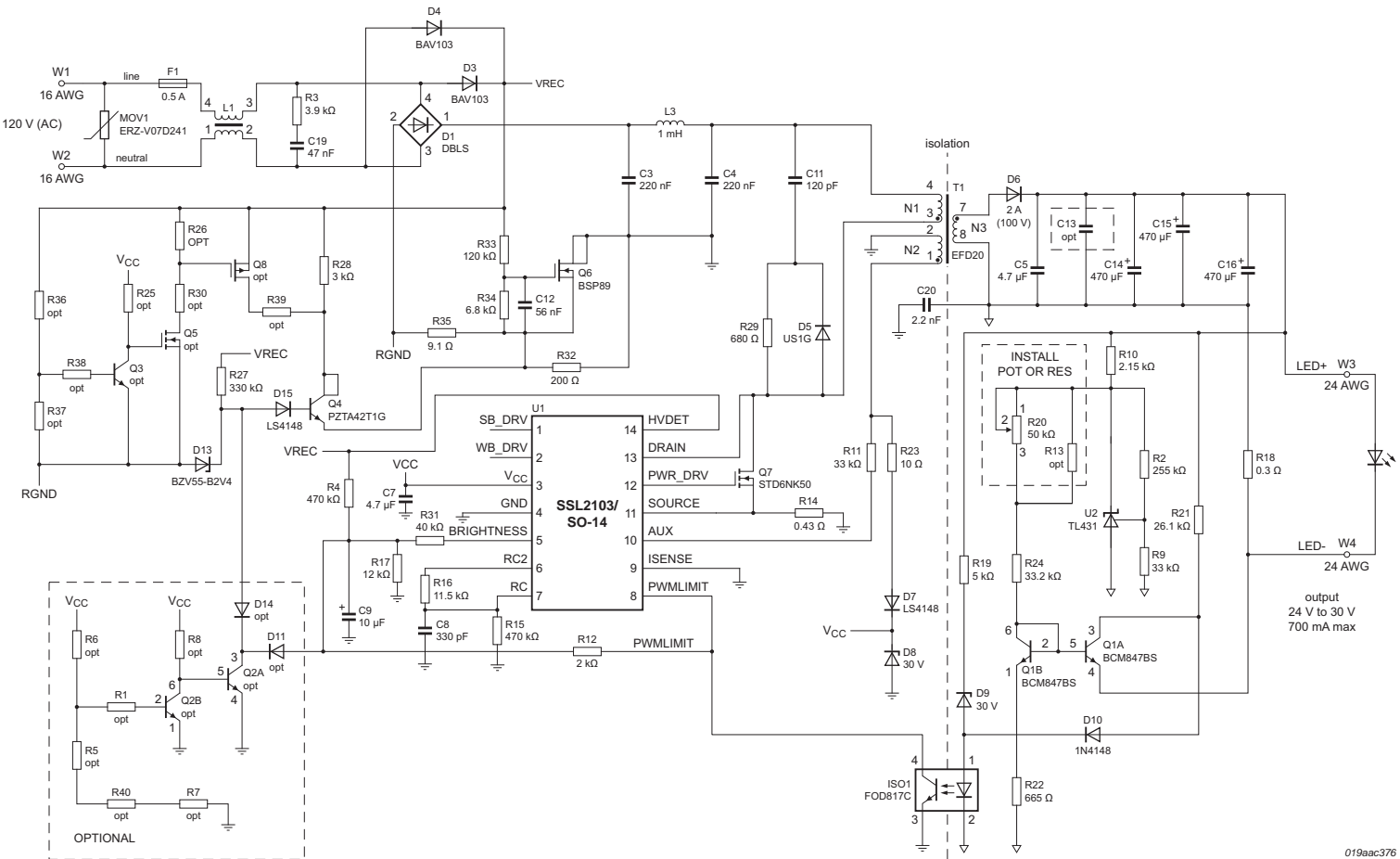

Fig 9. EMI performance

9. Circuit diagrams



019aac376

Fig 10. Demo board circuit diagram

10. Bill Of Materials (BOM)

[Table 3](#) provides detailed component information for the SSL2103 (120 V) demo board. [Figure 10](#) shows the circuit diagram with the top and bottom board layouts shown in [Section 11](#).

Table 3. BOM for the SSL2103 120 V 21 W demo board

Reference	Component	Package	Quantity	Part number	Remarks
C12	56 nF; 16 V;±10 %	0603	1	GRM188R71C223KA01D	Murata
C8	330 pF; 25 V; 5 %	C0603	1	06033A331JAT2A	AVX
C5; C7	4.7 µF; 50 V;±10 %	C1206	2	UMK316BJ475KL-T	Taiyo Yuden
C11	120 pF; 250 V;±5 %	C0603	1	C1608C0G2E121J	TDK
C19	47 nF; 250 V;±20 %	C1206	1	C3216X7R2E473M	TDK
C9	10 µF; 16 V; 10 %	C0805	1	GRM21BR61C106KE15L	Murata
C20	2.2 nF; 2 KV; 10 %	Thru-hole	1	DEBB33D222KA2B	Murata
C3; C4	220 nF; 10 %	Thru-hole	2	ECW-F2W224JAQ	Panasonic
C14; C15; C16	470 µF;±20 %	Thru Hole	3	EKY-350ELL471MJ20S	Panasonic - ECG
D1	1.5 A; 400 V	SMD_DBLS	1	DF04S	Fairchild
D7; D15	0.3 A; 100 V	SMD_LL-34	2	LS4148-GS08	Vishay
D5	1 A; 400 V	SMA_US1G	1	US1G	Micro Commercial
D6	2 A; 100 V	SMA_3A	1	SS2H10-E3/52T	Vishay
D8	30 V; 5 %	SOD80C	1	BZV55-B30	NXP Semiconductors
D9	30 V; 5 %	SOD80C	1	BZV55-B30	NXP Semiconductors
D10	0.2 A; 100 V	DO-35-V	1	1N4148,133	NXP Semiconductors
D3; D4	0.25;200 V	SOD80C	2	BAV103,115	NXP Semiconductors
D13	2.4 V	SOD123	1	BZV55-B2V4	NXP Semiconductors
F1	0.5 A; 250 V	SMD 2410	1	SSQ 500	Bel Fuse
ISO1	300 % CTR; 70 V	SMD-LTV817_L	1	FOD817C3S	Fairchild
L1	744821120	Thru-hole	1	744821120	Würth Electronics Midcom
L2	1 mH; 0.33 A;±10 %	Thru-hole	1	13R105C	Murata
MOV1	200 V; 21 J	Thru_hole	1	ERZ-V07D241	Panasonic
R2	255 kΩ;±1 %	0603	1	RC0603FR-07255KL	Yageo
R3	3.9 kΩ;±1 %	1206	1	RC1206FR-073K9L	Yageo
R4	470 kΩ;±1 %	R1206	1	RC1206FR-07470KL	Yageo
R9	33 kΩ;±1 %	R0603	1	ERJ-3GEYJ333V	Panasonic
R10	2.15 kΩ;±1 %	0603	1	ERJ-3EKF2151V	Panasonic
R12	2 kΩ;±1 %	R0603	1	RC0603FR-072KL	Yageo
R31	40 kΩ;±1 %	R0603	1	RMCF0603FT40K2	Stackpole Electronics
R34	6.8 kΩ;±5 %	R0603	1	RMCF 1/16 6.8 kΩ 5 % R	Stackpole Electronics
R15	470 kΩ;±1 %	R0603	1	RMCF 1/16 470 kΩ 1 % R	Stackpole Electronics
R16	11.5 kΩ;±1 %	R0603	1	RMCF0402FT 11.5 kΩ 1 %	Stackpole Electronics
R19	5.1 kΩ;±1 %	R0603	1	RMCF 1/16 5.1 kΩ 1 % R	Stackpole Electronics

Table 3. BOM for the SSL2103 120 V 21 W demo board ...continued

Reference	Component	Package	Quantity	Part number	Remarks
R17	12 k Ω ;±5 %	R0603	1	ERJ-3GEYJ123V	Panasonic
R20	50 k Ω POT;±20 %	SMD	1	PVG3A503C01R00	Murata
R21	26.1 k Ω ;±1 %	R0603	1	RMCF0603FT26K1	Stackpole Electronics
R22	665 Ω ;±1 %	R0603	1	RC0603FR-07665RL	Yageo
R24	33.2 k Ω ;±5 %	R0603	1	ERJ-3EKF3322V	Panasonic
R11,	33 k Ω ;±1 %	R0603	1	ERJ-3GEYJ333V	Panasonic
R14	0.43 Ω ;±1 %	R0805	1	MCR10EZHFLR430	ROHM
R23	10 Ω ;±5 %	R0603	1	ERJ-3GEYJ100V	Panasonic
R27	330 k Ω ;±1 %	R1206	1	RMCF 1/8 330 k Ω 5 % R	Stackpole Electronics
R33	120 k Ω ;±5 %	R1206	1	RMCF1206JT120K	Stackpole Electronics
R32	200 Ω ;0.25 W;±5 %	Thru-hole	1	CFR-25JR-200R	Yageo
R18	0.3 Ω ;±1 %	R1206	1	CSR1206FKR300	Stackpole Electronics
R28	3 k Ω ;1 W;±5 %	Thru-hole	1	FMP100JR-52-3K	Yageo
R29	680 Ω ±5 %	Thru-hole	1	CFR-25JR-680R	Yageo
R35	9.1 Ω ;0.25 W;±5 %	Thru-hole	1	ERD-S1TJ9R1V	Panasonic
Q1A; Q1B	100 mA; 30 V	SOT143	1	BCM847BS,135	NXP Semiconductors
Q4	0.1 A; 300 V	SOT223	1	PZTA42,115	NXP Semiconductors
Q6	0.375 A; 240 V NFET	SOT223	1	BSP89, 115	NXP Semiconductors
Q7	5.6 A; 500 V	DPAK	1	STD6NK50	ST Microelectronics
T1	MA5157-AL	Thru-hole	1	MA5157-AL	Coilcraft
U1	SSL2103	SO-14	1	SSL2103/SO-16	NXP Semiconductors
U2	TL431;1 %	SOT23-3	1	TL431AQDBZR,215	NXP Semiconductors

11. Demo board layout

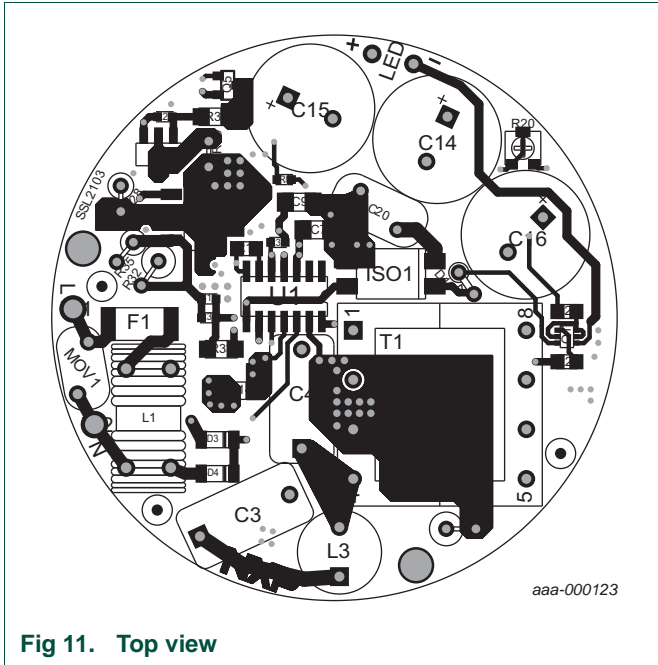

Fig 11. Top view

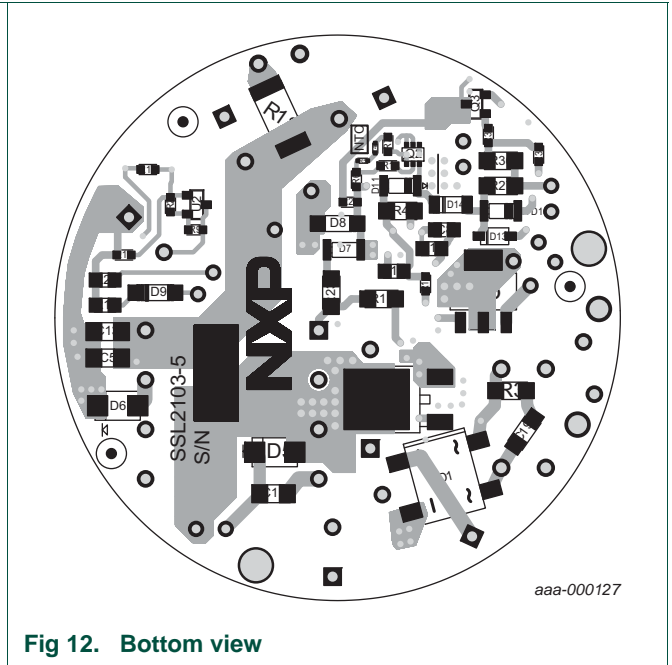

Fig 12. Bottom view

12. Abbreviations

Table 4. Abbreviations

Acronym	Description
BCM	Boundary Conduction Mode
DCM	Discontinuous Conduction Mode
EMC	ElectroMagnetic Compatibility
EMI	ElectroMagnetic Interference
LED	Light Emitting Diode
MOSFET	Metal-Oxide Semiconductor Field-Effect Transistor
PF	Power Factor
SMPS	Switched Mode Power Supply

13. References

- [1] **SSL2103** — Data sheet: SMPS controller IC for dimmable LED lighting.

14. Legal information

14.1 Definitions

Draft — The document is a draft version only. The content is still under internal review and subject to formal approval, which may result in modifications or additions. NXP Semiconductors does not give any representations or warranties as to the accuracy or completeness of information included herein and shall have no liability for the consequences of use of such information.

14.2 Disclaimers

Limited warranty and liability — Information in this document is believed to be accurate and reliable. However, NXP Semiconductors does not give any representations or warranties, expressed or implied, as to the accuracy or completeness of such information and shall have no liability for the consequences of use of such information.

In no event shall NXP Semiconductors be liable for any indirect, incidental, punitive, special or consequential damages (including - without limitation - lost profits, lost savings, business interruption, costs related to the removal or replacement of any products or rework charges) whether or not such damages are based on tort (including negligence), warranty, breach of contract or any other legal theory.

Notwithstanding any damages that customer might incur for any reason whatsoever, NXP Semiconductors' aggregate and cumulative liability towards customer for the products described herein shall be limited in accordance with the *Terms and conditions of commercial sale* of NXP Semiconductors.

Right to make changes — NXP Semiconductors reserves the right to make changes to information published in this document, including without limitation specifications and product descriptions, at any time and without notice. This document supersedes and replaces all information supplied prior to the publication hereof.

Suitability for use — NXP Semiconductors products are not designed, authorized or warranted to be suitable for use in life support, life-critical or safety-critical systems or equipment, nor in applications where failure or malfunction of an NXP Semiconductors product can reasonably be expected to result in personal injury, death or severe property or environmental damage. NXP Semiconductors accepts no liability for inclusion and/or use of NXP Semiconductors products in such equipment or applications and therefore such inclusion and/or use is at the customer's own risk.

Applications — Applications that are described herein for any of these products are for illustrative purposes only. NXP Semiconductors makes no representation or warranty that such applications will be suitable for the specified use without further testing or modification.

Customers are responsible for the design and operation of their applications and products using NXP Semiconductors products, and NXP Semiconductors accepts no liability for any assistance with applications or customer product design. It is customer's sole responsibility to determine whether the NXP Semiconductors product is suitable and fit for the customer's applications and products planned, as well as for the planned application and use of customer's third party customer(s). Customers should provide appropriate design and operating safeguards to minimize the risks associated with their applications and products.

NXP Semiconductors does not accept any liability related to any default, damage, costs or problem which is based on any weakness or default in the customer's applications or products, or the application or use by customer's third party customer(s). Customer is responsible for doing all necessary testing for the customer's applications and products using NXP Semiconductors products in order to avoid a default of the applications and the products or of the application or use by customer's third party customer(s). NXP does not accept any liability in this respect.

Safety of high-voltage evaluation products — The non-insulated high voltages that are present when operating this product, constitute a risk of electric shock, personal injury, death and/or ignition of fire. This product is intended for evaluation purposes only. It shall be operated in a designated test area by personnel that is qualified according to local requirements and labor laws to work with non-insulated mains voltages and high-voltage circuits.

The product does not comply with IEC 60950 based national or regional safety standards. NXP Semiconductors does not accept any liability for damages incurred due to inappropriate use of this product or related to non-insulated high voltages. Any use of this product is at customer's own risk and liability. The customer shall fully indemnify and hold harmless NXP Semiconductors from any liability, damages and claims resulting from the use of the product.

Export control — This document as well as the item(s) described herein may be subject to export control regulations. Export might require a prior authorization from competent authorities.

Evaluation products — This product is provided on an "as is" and "with all faults" basis for evaluation purposes only. NXP Semiconductors, its affiliates and their suppliers expressly disclaim all warranties, whether express, implied or statutory, including but not limited to the implied warranties of non-infringement, merchantability and fitness for a particular purpose. The entire risk as to the quality, or arising out of the use or performance, of this product remains with customer.

In no event shall NXP Semiconductors, its affiliates or their suppliers be liable to customer for any special, indirect, consequential, punitive or incidental damages (including without limitation damages for loss of business, business interruption, loss of use, loss of data or information, and the like) arising out of the use of or inability to use the product, whether or not based on tort (including negligence), strict liability, breach of contract, breach of warranty or any other theory, even if advised of the possibility of such damages.

Notwithstanding any damages that customer might incur for any reason whatsoever (including without limitation, all damages referenced above and all direct or general damages), the entire liability of NXP Semiconductors, its affiliates and their suppliers and customer's exclusive remedy for all of the foregoing shall be limited to actual damages incurred by customer based on reasonable reliance up to the greater of the amount actually paid by customer for the product or five dollars (US\$5.00). The foregoing limitations, exclusions and disclaimers shall apply to the maximum extent permitted by applicable law, even if any remedy fails of its essential purpose.

14.3 Trademarks

Notice: All referenced brands, product names, service names and trademarks are the property of their respective owners.

15. Tables

Table 1.	Performance and specification [1]	4
Table 2.	Dimmer compatibility	5
Table 3.	BOM for the SSL2103 120 V 21 W demo board	10
Table 4.	Abbreviations	13

continued >>

16. Figures

Fig 1. SSL2103 demo board (top view)3
 Fig 2. SSL2103 demo board (bottom view)3
 Fig 3. Variable transformer isolation symbols4
 Fig 4. Correct measurement setup6
 Fig 5. Efficiency7
 Fig 6. Power factor.7
 Fig 7. Output current ripple7
 Fig 8. Output current7
 Fig 9. EMI performance8
 Fig 10. Demo board circuit diagram.9
 Fig 11. Top view.12
 Fig 12. Bottom view12

continued >>

17. Contents

1	Introduction	3
1.1	Scope of this document	3
2	Safety warning	4
3	Specification	4
3.1	Demo board performance and specification ...	4
4	Functional description	4
5	Dimmer compatibility	5
6	Quick setup procedure	6
7	Performance data (9 Cree XPE LEDs)	7
8	EMI performance	8
9	Circuit diagrams	9
10	Bill Of Materials (BOM)	10
11	Demo board layout	12
12	Abbreviations	13
13	References	13
14	Legal information	14
14.1	Definitions	14
14.2	Disclaimers	14
14.3	Trademarks	14
15	Tables	15
16	Figures	16
17	Contents	17

Please be aware that important notices concerning this document and the product(s) described herein, have been included in section 'Legal information'.

© NXP B.V. 2011.

All rights reserved.

For more information, please visit: <http://www.nxp.com>

For sales office addresses, please send an email to: salesaddresses@nxp.com

Date of release: 21 December 2011

Document identifier: UM10475